

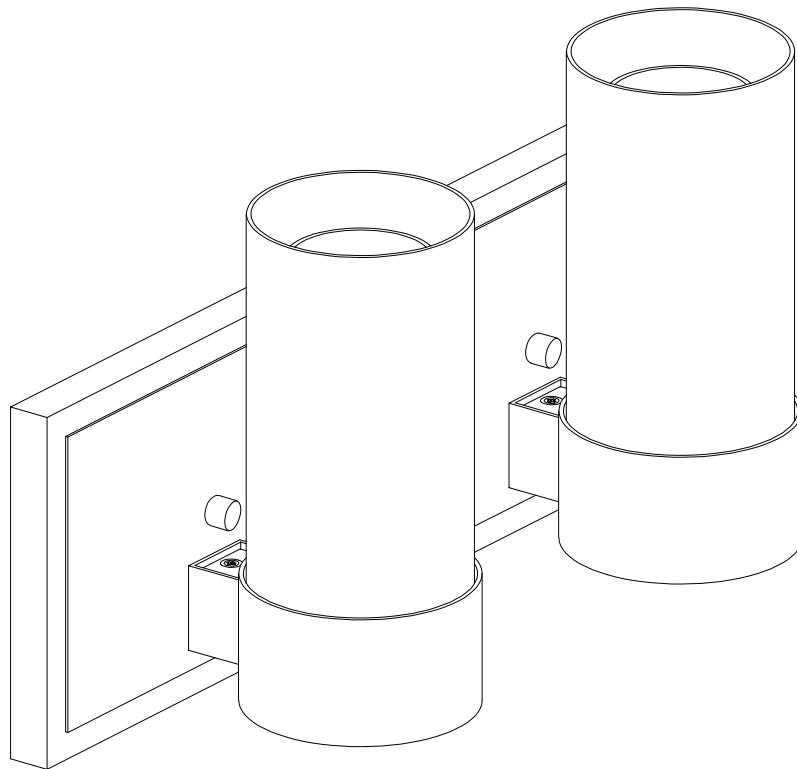

Item/Model Number:23072

Silo 2-Light Bath Vanity



Lamping | Ampoule:2xG9 40W(Included)



Please consult a qualified electrician prior to install











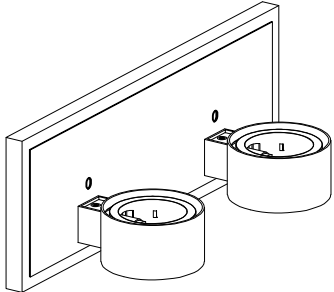
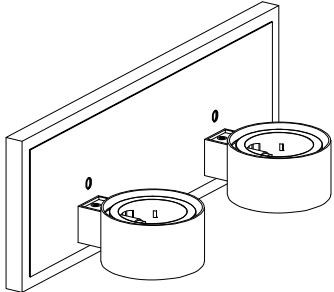
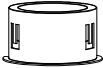
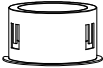
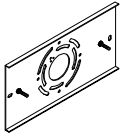
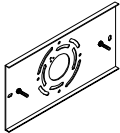

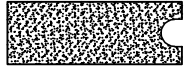
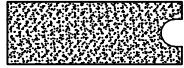

Veuillez consulter un électricien qualifié pour suspendre le luminaire et le câblage.

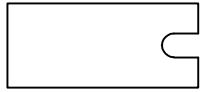
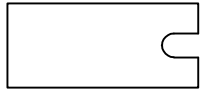
Made in China | Fabrique en Chine | Hecho en China

## XENON LAMPS

| English <b>Before Getting Started</b>   | Français <b>Avant de Commencer</b>   | Español <b>Antes de Comenzar</b>   |
|---|--|--|
| Read the instructions carefully prior to assembling the product.  | Lire attentivement les instructions avant d'assembler le produit.  | Lea atentamente las instrucciones antes de ensamblar el producto.  |
| When you open the package with a sharp tool like a box knife, be careful not to damage the components inside.   | Lorsque vous ouvrez le paquet avec un outil pointu comme un couteau de coupe, veillez à ne pas endommager les composants à l'intérieur.  | Cuando abra el paquete con una herramienta afilada como un cuchillo de corte, tenga cuidado de no dañar los componentes dentro.  |
| Carefully remove all packaging materials and retain for future use.   | Retirez soigneusement tous les matériaux d'emballage et conservez-les pour un usage ultérieur.   | Retire con cuidado todos los materiales de embalaje y consérvelos para usarlos en el futuro.   |
| Keep all hardware parts and packaging out of reach of small children.   | Conservez toutes les pièces matérielles et les emballages hors de portée des petits enfants.   | Mantenga todas las piezas y embalajes de hardware fuera del alcance de los niños pequeños.   |
| Choose a clean, level, spacious assembly area. Avoid hard surfaces that may damage the product.   | Choisissez une zone d'assemblage propre, de niveau et spacieuse. Évitez les surfaces dures qui pourraient endommager le produit.   | Elija una zona de ensamblaje limpia, nivelada y espaciosa. Evite superficies duras que puedan dañar el producto.   |
| Ensure that you have all required contents for complete assembly.   | Assurez-vous que vous avez tous les contenus requis pour l'assemblage complet.   | Asegúrese de que tiene todos los contenidos necesarios para el ensamblaje completo.  |
| Take care when lifting. Assemble the product in close proximity to where you intend to install it.  | Prenez soin de soulever. Assemblez le produit à proximité de l'endroit où vous comptez positionner l'élément.  | Tenga cuidado al levantar. Ensamble el producto cerca de donde tiene la intención de posicionar el artículo.   |
| Do not over tighten the screws and bolts as this may damage the threads.  | Ne serrez pas trop les vis et les boulons car cela pourrait endommager les filets.   | No apriete excesivamente los tornillos y pernos, ya que esto puede dañar los hilos.  |
| Do not let children play with this product.   | Ne laissez pas les enfants jouer avec ce produit.  | No permita que los niños jueguen con este producto.  |
|  <b>Risk of suffocation!</b><br>Keep packaging materials away from children.                                      |  <b>Risque asphyxie!</b><br>Tenez tous les matériaux emballage à l'écart des enfants  |  <b>Riesgo de sofocación!</b><br>Mantenga los materiales de emb/alaje lejos de los niños.   |
| <b>Lamp Care Instructions</b>   | <b>Entretien de la Lampe</b>   | <b>Instrucciones de Lámparas</b>   |
| Carefully read through the instruction sheet before assembly and using the product.   | Avant de procéder à l'assemblage et à l'utilisation de la lampe, lisez attentivement le mode d'emploi.   | Lea cuidadosamente la hoja de instrucciones (si fue proporcionada) antes de armar y utilizar la lámpara.   |
|  <b>Caution there is a risk of shock!</b><br>Disconnect from power source before assembling or cleaning.        |  <b>Pour éviter tout risque d'électrocution,</b> débranchez la lampe de la prise électrique avant de procéder à l'assemblage ou au nettoyage de la lampe. |  <b>Peligro por descarga eléctrica.</b> Desconecte la lámpara de la fuente de electricidad antes de armarla o limpiarla.                                  |
| Switch off, unplug and allow bulb to cool before replacing bulb or cleaning.  | Avant de remplacer ou de nettoyer l'ampoule, éteignez et débranchez la lampe.  | Apáguela, desenchúfela y deje que la bombilla se enfríe antes de reemplazarla o limpiarla.   |
| Only <b>use the recommended</b> bulb type and do not exceed the maximum wattage as it could cause fire.   | Afin d'éviter tout risque de feu, utilisez le type et la puissance d'ampoule recommandés.  | Solo utilice el tipo de bombilla recomendado y no exceda la potencia eléctrica máxima ya que puede causar un incendio.   |
| Check the product cord to be sure is free torn or frayed.   | Ne branchez pas la lampe si son cordon d'alimentation est déchiré ou effiloché   | No conecte la lámpara si el cable eléctrico está dañado o deshilachado.  |
|  <b>Caution:</b> Xenon bulbs may burn you. Lamps should remain off for a minimum of 10 minutes before handling. |  <b>Attention:</b> Les ampoules au xénon peuvent vous brûler. Les lampes doivent rester éteintes pendant au moins 10 minutes avant la manipulation.       |  <b>Precaución:</b> Las bombillas de xenón pueden quemarlo. Las lámparas deben permanecer apagadas durante un mínimo de 10 minutos antes de manipularlas. |
| <b>Cleaning &amp; Maintenance</b>   | <b>Nettoyage et Maintenance</b>  | <b>Limpieza y Mantenimiento</b>  |
| On polished finishes, often using talc powder can reduce the appearance of fingerprints and other smudges.  | Sur les finitions polies, souvent en utilisant la poudre de talc réduit l'apparence des empreintes digitales et d'autres taches.   | En acabados pulidos, a menudo usando polvo de talco reduce la aparición de huellas dactilares y otras manchas.   |
| For respective shade surfaces, use the appropriate cleansers, i.e. glass cleaner, stone polish, & wood polish.  | Pour les surfaces d'ombrage respectives, utilisez les nettoyants appropriés, c'est-à-dire le nettoyant pour vitres, vernis à pierre et le vernis à bois.   | Para las respectivas superficies de sombra, utilice los limpiadores apropiados, es decir, limpiador de vidrio, esmalte acrílico y pulido de madera.  |
| Clean with soft cloth and a mild detergent. Do not use abrasive or harsh cleaners.  | Nettoyer avec un chiffon doux et un détergent doux. N'utilisez pas de nettoyant abrasif.   | Utilice un trapo limpio, suave y seco que no raye ni manche la superficie cuando quite el polvo.   |
| Periodically (every 90-180 days) make sure that the screws are fully tightened.   | Périodiquement (tous les 90-180 jours), assurez-vous que les vis sont bien serrées.  | Periódicamente (cada 90-180 días) asegúrese de que los tornillos estén bien apretados.   |
| Prolonged exposure to heat sources may cause glazing, melting and scorching, or even cause color to fade.   | Si le tissu subit une exposition prolongée aux sources de chaleur, il pourrait commencer à reluire, à roussir, à s'estomper ou même à se décolorer.  | La exposición prolongada a las fuentes de calor causa cristalización, derretimiento, quemadura y decoloración del tapizado.  |

|  <b>PARTS</b> |  <b>PIÈCES</b> |  <b>PASRTES</b> |
|--|---|--|
| Before getting started, ensure the package contains the following components:                  | Antes de comenzar, asegúrese de que el paquete contenga los siguientes componentes:             | Avant de commencer, assurez-vous qu le paquet contient les composants suivants:                    |

|   |  |    |   |   |    |
|---|--|----|---|---|----|
|    |                   | X1 |    |                              | X2 |
|    |                   | X1 |    | <br>BX40G9FT120V             | X2 |
|  | <br>#8-32X1"    | X2 |    | <br>GLS23071FTI 2"W x 5.5"H  | X2 |
|  |                 | X2 |  | <br>GLS23071CL 3"W x 6.7"H | X2 |
|  |                 | X3 |  | <br>#9-40 x 1"             | X2 |
|  |                 | X2 |   |   |    |
|  | <br>GLS23071FTB | X2 |   |   |    |

1.

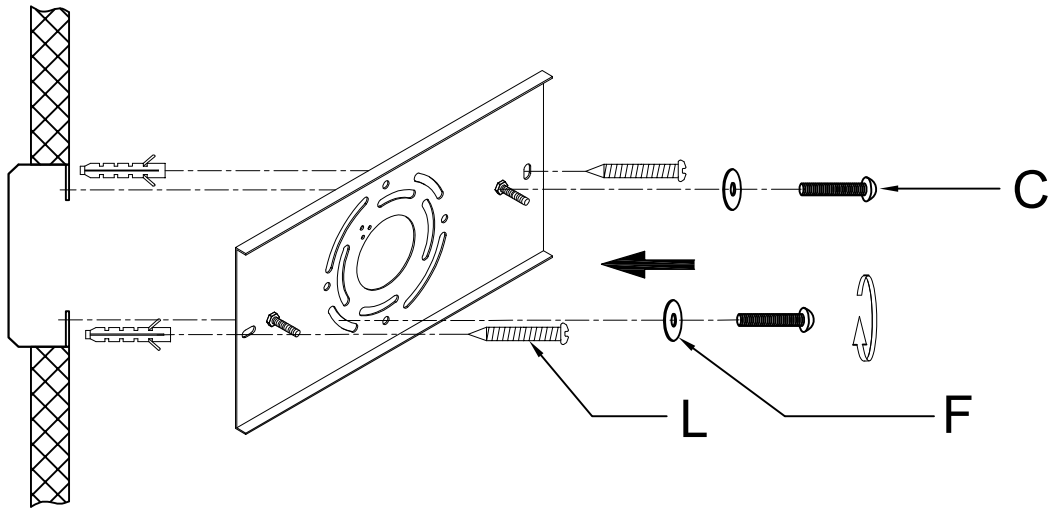

2.

